

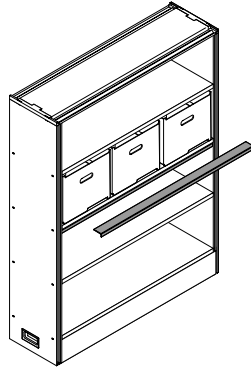

# Storage Wall

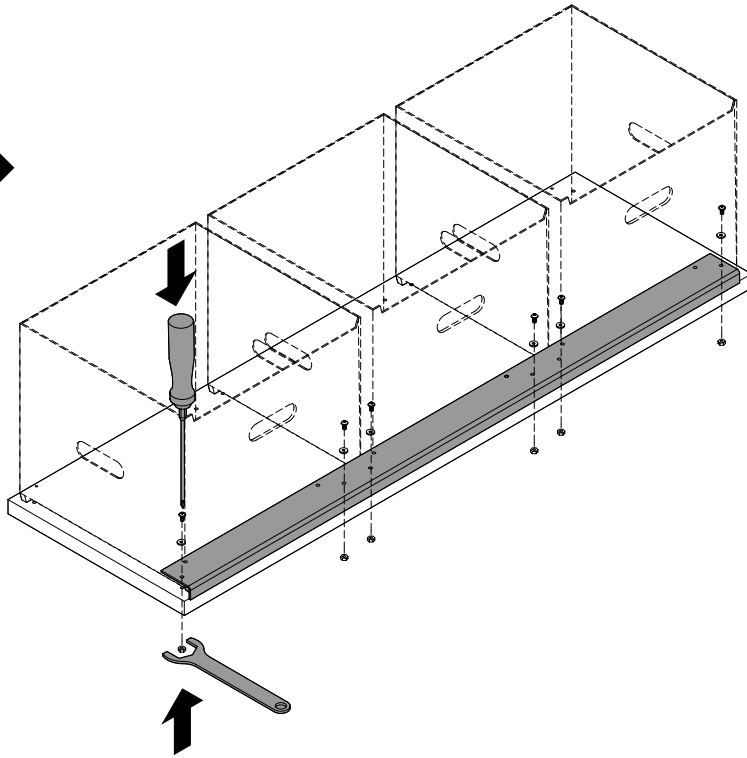

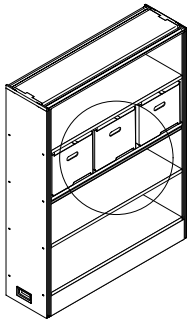

**A**



6x  
M5x10  

6x  

6x  

  
● = SW3

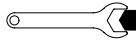
  
● = SW8