

Tyde 2

Ronan & Erwan Bouroullec, 2021



vitra.



Alternating between sitting and standing while working on the computer has proven to have health benefits, in contrast to just sitting. However, when planning office environments to suit contemporary work concepts, compromises are often necessary. This is not the case with Tyde 2: the sit-stand table system offers multiple configuration and equipment options, making everything possible from a single desk to a large bench. Single desks, double clusters and conference tables can be transformed into platforms to offer solutions for concentrated tasks, dynamic teamwork and meetings. And Tyde 2 fulfils a key requirement of modern workplaces: configurations can be easily adapted to

changing situations and needs to ensure maximum flexibility. This is particularly true with the height-adjustable sit-stand tables on castors.

Tyde 2 is characterised by clean lines combined with rounded contours, giving even expansive structures an understated aesthetic. Cable management is neat and orderly thanks to a cable channel and other electrification features. Additional elements and accessories, such as lamp holders, monitor arms or screens, can be freely positioned and attached using the sophisticated Tyde 2 bracket system.

The table system comes in a choice of materials, making Tyde 2 a suitable addition to diverse settings. And the use of polyester fleece for the cable tray under the table top helps reduce noise in open-plan environments – particularly in combination with acoustic screens.



Ronan & Erwan Bouroullec

The brothers Ronan and Erwan Bouroullec live and work in Paris. Their oeuvre ranges from small everyday objects to architectural projects. They have worked with Vitra since 2000 and have contributed numerous designs to both the office and home collections.

1-3	Tyde 2	11	Tyde 2 – Cluster Meeting	15-20	Electrification
4-7	Configurations	12	Tyde 2 – Add-on table for cluster	21-23	Screens
8-9	Tyde 2 – Tables	13	Tyde 2 – Meeting	24-25	Accessories
	Tables on castors	14	Height adjustment	26-27	Colours & materials
10	Tyde 2 – Clusters			28-35	Dimensions



Sit-stand table on castors, table top in HPL (basic dark, anti-fingerprint) 180 x 80 cm.



Sit-stand table, table top in HPL (basic dark, anti-fingerprint) 140 x 70 cm, workstations equipped with a screen. The bracket mount for the screen simultaneously serves as an attachment point for a desk lamp and monitor arm.



Sit-stand platform: two sit-stand clusters combined with a sit-stand meeting cluster, table top in HPL (basic dark, anti-fingerprint) 160 x 80 cm. Continuous cable channel for end-to-end cable management, workstations fitted with cable outlets, meeting table equipped with two Port 180 electrification flaps.



Sit-stand cluster, table top in HPL (basic dark, anti-fingerprint) 160 x 80 cm, equipped with a cluster screen and a cable channel. The brackets serve as attachment points for desk lamps and monitor arms.



Sit-stand platform: two sit-stand clusters combined with a sit-stand add-on table at the end of the cluster, table top in HPL (basic dark, anti-fingerprint) 160 x 80 cm, cluster workstations equipped with a cluster screen. The side cluster screen can additionally serve as a boundary for circulation paths.



Sit-stand cluster, table top in HPL (basic dark, anti-fingerprint) 160 x 80 cm, equipped with a separate screen for each workstation. The bracket mount for the screen simultaneously serves as an attachment point for a monitor arm.



Sit-stand platform: sit-stand cluster combined with a sit-stand cluster meeting table and a sit-stand add-on table, table top in HPL (basic dark, anti-fingerprint). Continuous cable channel for joint power supply, cluster screen for visual and acoustic privacy.



Sit-stand meeting table 200 x 100 cm, table top in HPL (basic dark, anti-fingerprint), equipped with Port 180 electrification flap for direct access to power, USB charger etc.



Meeting table 200 x 100 cm, table top in HPL (basic dark, anti-fingerprint), equipped with one Port 180 electrification flap.



Sit-stand meeting table 260 x 130 cm, table top in HPL (basic dark, anti-fingerprint) with two Port 180 electrification flaps.



Meeting table 260 x 130 cm, table top in HPL (basic dark, anti-fingerprint) with two Port 180 electrification flaps.



Sit-stand meeting table 340 x 130 cm, two-part table top in HPL (basic dark, anti-fingerprint) with two Port 180 electrification flaps.



Meeting table 340 x 130 cm, two-part table top in HPL (basic dark, anti-fingerprint).

Tyde 2 – Tables

vitra.

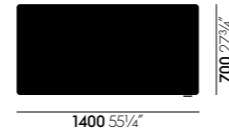

Tyde 2 table 140

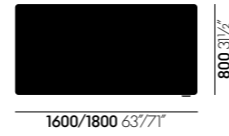

Tyde 2 sit-stand table 160/180

Tyde 2 – Tables

The single tables are available in three sizes, either with an electrically adjustable height range from 65 to 125 cm, or at a fixed height of 74 cm.



Extensions

Two single tables can be linked together side-by-side or face-to-face with connecting elements. Single tables can be reconfigured into double workstations with the cluster bridge.

Screens and accessories

Screens increase privacy and are sound-absorbing. They are attached to the table top with brackets and can also be retrofitted. Each bracket has a mounting point and can be fitted with adapters for lamps or monitor arms.

Electrification

Optional cable outlets in the table top facilitate easy cable routing to the desk surface. There are various options for under-table cable management: a polyester fleece cable cover, which can be combined with a metal cable tray, or a cable tray made of polyester fleece.

Tyde 2 – Tables on castors

vitra.

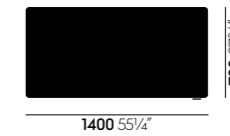

Tyde 2 table 140



Tyde 2 sit-stand table 160/180



Tyde 2 sit-stand tables are optionally available on castors – with the full range of accessories and electrification options, except the use of screens. The table top is fitted with a hook for the storage of cables. Existing sit-stand tables can be retrofitted with castors. For more information, please contact your Vitra representative.



The hook is always situated on the left-hand side and allows the safe storage of cables while the table is being moved.



The hook can also be used to hold bags or helmets and supports a maximum weight of 10 kg.



All castors can be securely locked for stability and are available in black or white.

Tyde 2 – Clusters



vitra.

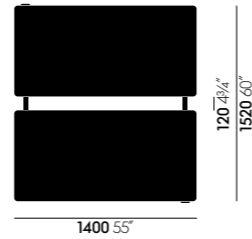

Tyde 2 cluster 140

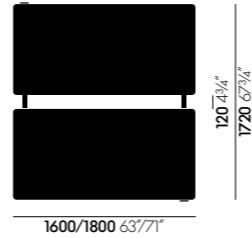

Tyde 2 cluster 160/180

Tyde 2 - Clusters

Clusters are single tables joined together with a cluster bridge to form a double workstation. The tables for double workstations are available in three sizes, either with an electrically adjustable height range from 65 to 125 cm, or at a fixed height of 74 cm.



Extension and reconfiguration

Clusters can be linked side-by-side with a connecting cable channel or with a simple linking element. Add-on tables and cluster meeting tables offer further options for creating platforms. Double workstations can be transformed into single tables by removing the cluster bridge.

Screens

Cluster screens and cluster side screens provide visual privacy and enhanced acoustics. Both screens are attached to the cluster bridge and have a fixed height of 130 cm (measured from the floor). The screen for single tables, which is attached with brackets, can also be mounted on the tables in a cluster configuration, where it moves up and down with the table to which it is attached.

Electrification

Cluster workstations can be fitted with the same accessories as single tables. Furthermore, the cable channel for clusters offers options for supplying power to all of the workstations in a cluster.

Tyde 2 – Cluster Meeting



vitra.

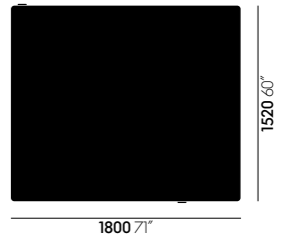

Tyde 2 meeting cluster 140

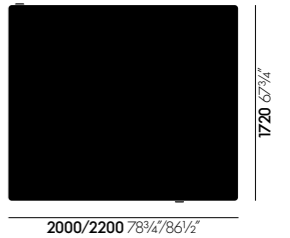

Tyde 2 meeting cluster 160/180

Cluster meeting table

Meeting tables for clusters have the same base as a double workstation. The continuous table top is extended on its open end to provide room for a chair around all three sides – as an invitation for spontaneous conversations or meetings. Meeting tables for clusters are available in three sizes, either with an electrically adjustable height range from 65 to 125 cm, or at a fixed height of 74 cm.

Electrification

Cluster workstations can be fitted with the same accessories for under-table cable management as single tables. The cable channel is also available for cluster meeting tables and enables end-to-end cable management. The Port 180 electrification flap provides direct access to max. 2 sockets that can be optionally configured with power outlets, USB chargers, RJ45 etc.



Platform: cluster for 4, extended with cluster meeting table



Non-territorial workspace: cluster for 2 with cluster meeting table and add-on table for cluster.

Tyde 2 – Add-on table for cluster

vitra.

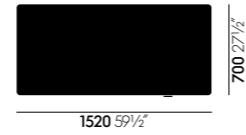

Tyde 2 Add-on table for cluster 140

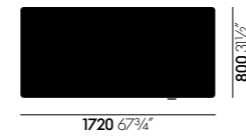

Tyde 2 Add-on table for cluster 160/180

Add-on table for cluster

Add-on tables for clusters are individual tables that are positioned perpendicular to a cluster on one end. They are available in two sizes, either with an electrically adjustable height range from 65 to 125 cm, or at a fixed height of 74 cm. Add-on tables can also be retrofitted.

Electrification:

Add-on tables can be fitted with the same accessories as single tables.



Team workstation: cluster for 4 with add-on table



Workstation for 3: cluster with add-on table, optional bracket mount for lamp or monitor adapter.

Tyde 2 – Meeting

vitra.

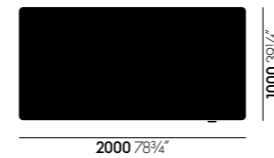

Tyde 2 meeting table 200



Tyde 2 meeting table 260

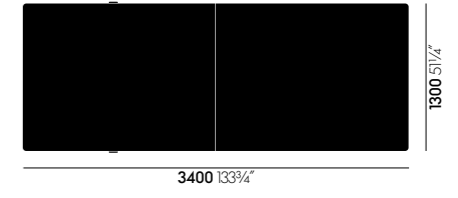

Tyde 2 meeting table 340

Meeting tables

The meeting tables come in three sizes that correspond to the single tables and cluster configurations. They are optionally available with an electrically adjustable height range from 65 to 125 cm, or at a fixed height of 74 cm.



Electrification

Like the work tables, the meeting tables are equipped with a cable tray made of polyester fleece. The Port 180 electrification flap provides direct access to max. 2 sockets that can be optionally configured with power outlets, USB chargers, RJ45 etc.

Height adjustment

vitra.

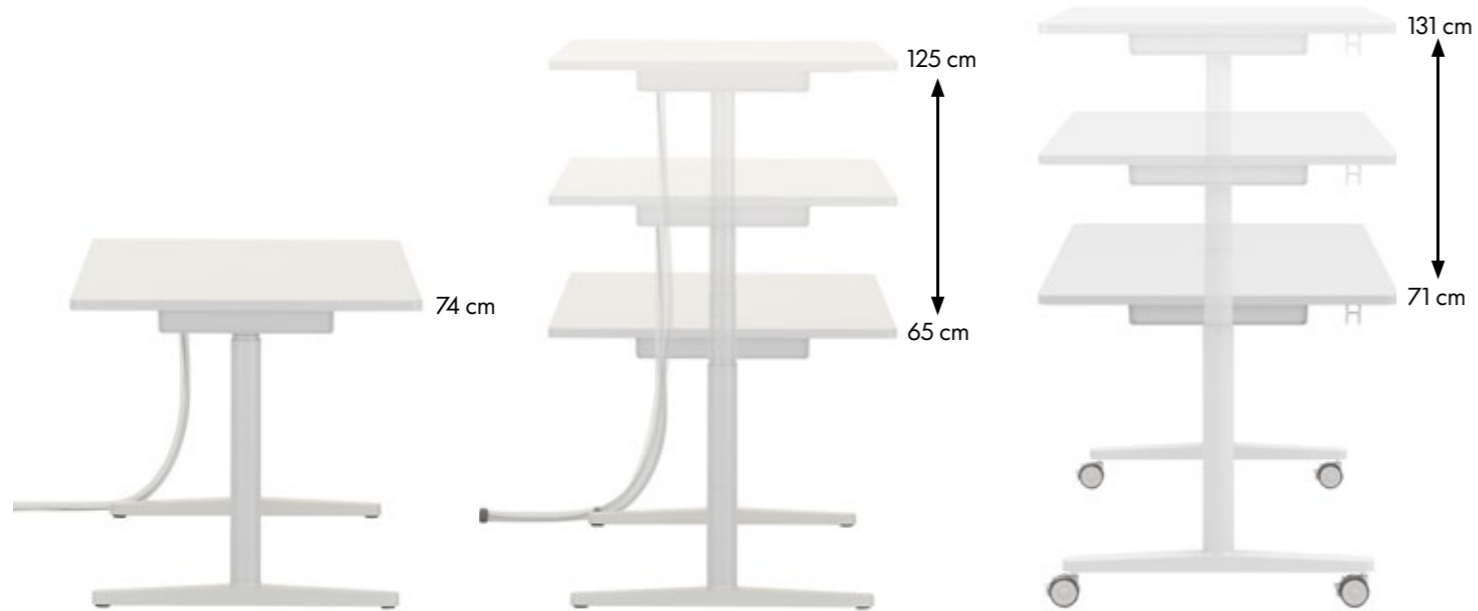

Fixed table height 74 cm

Electric height adjustment 65 - 125 cm

Electric height adjustment for tables on castors 71 - 131 cm



Simple handset

Regulates the table height with an intuitive up-and-down lever switch.



Handset with memory function and display

In addition to controlling the height adjustment, the deluxe handset also has an OLED display, a memory function with up to four saved settings for different table heights, and the option of connecting to the Desk Control™ app to specify the desired intervals for working in sitting and standing positions.

Electrification

vitra.



Cover made of polyester fleece

The cover encases the tubular frame elements along the entire length and completely conceals the electric components of the height-adjustment mechanism. The anti-collision sensor beneath the table top is also concealed under the cover.

The cable cover is attached to the table top and the frame tubes. This ensures that the user only has access to the electrical elements needed for working at the desk.

Despite its soft texture and slight pliability, the polyester fleece material retains its shape and contributes to good interior acoustics with its sound-absorbing properties.



Metal cable tray (optional)

The polyester fleece cover can be optionally supplemented with a metal cable tray. By pushing up against the bottom, the catch is released and the tray hinges downward to open. It serves as a cover for the electrical components underneath the table top and holds excess cable. Cables can be routed to the desktop from the rear anywhere along the entire length of the table.

Tyde 2 electrification – work tables

vitra.



Cable outlet for simple and tidy power supply

The outlet routes cables from power sockets underneath the table to the desktop. Measuring 80 mm in diameter, it is compatible with many other power and data solutions for desk systems on the market.

Tyde 2 electrification – meeting tables



Doppio

Doppio opens from both sides, making it an ideal solution for meeting tables. Cables can be routed to the tabletop even when the flap is closed, and the flap can also be easily removed to allow full access to the electrification.

Tyde 2 electrification – meeting tables

vitra.

Port 180 for meeting tables

Port 180 accommodates up to two sockets that can be optionally configured with power, active USB, HDMI etc.



Port 180 with 2x power



Port 180 with 1x power and cable holder



Port 180 with 1x power and 1x USB A/C charger



Port 180 with 1x power and 1x USB charger



Cable tray made of polyester fleece

The moulded cable tray made of polyester fleece covers the entire frame construction and electrical components while also providing enough storage space to accommodate under-table power sockets and hold excess cable. Although it is attached underneath the work surface, the polyester cable tray lends the table a certain home-like quality, while concealing the technical elements and emphasising the meticulous design of the desking system. The material also has effective sound-absorbing properties.

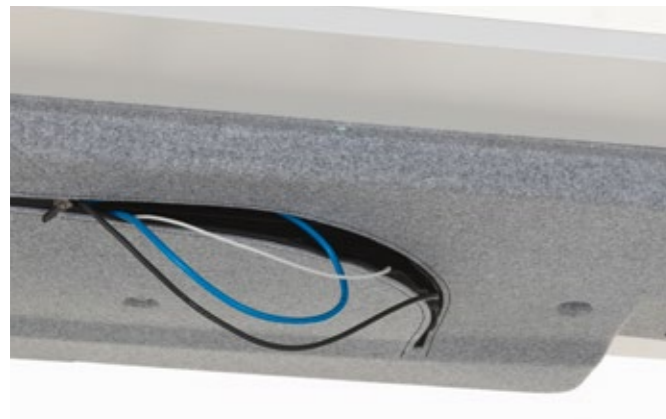

Zip fastener

A zip fastener provides easy access to the under-table electrical components.



Press stud flap

A flap with press studs along the back opens to enable cable routing to the table top.



Cable channel

Clusters can be equipped with a cable channel – also retroactively. With the help of linking elements, the channel can be continuously linked along the entire length of several clusters, providing storage space for cables, distributors and power sockets.

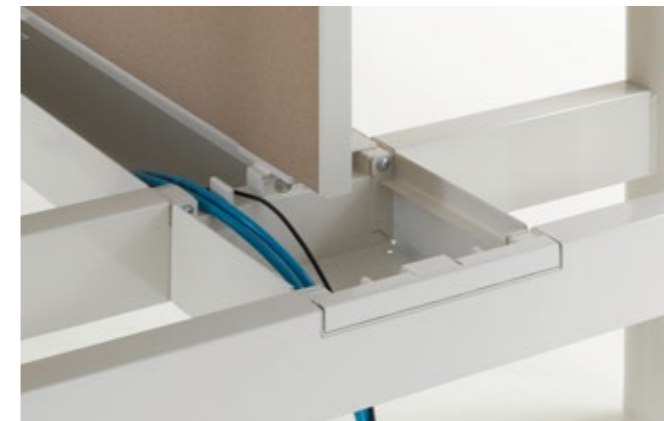

Easy access

The two-part metal cover flaps can be completely removed. This allows easy access to cables. The end pieces of the cover flap are attached with magnets and can be simply removed when clusters are linked together.



Concealed cable management

When closed, the cable channel forms a continuous flush surface with the cluster bridge, so that no cables are visible. Cables can be routed either laterally within the channel or downwards to a floor socket through openings.

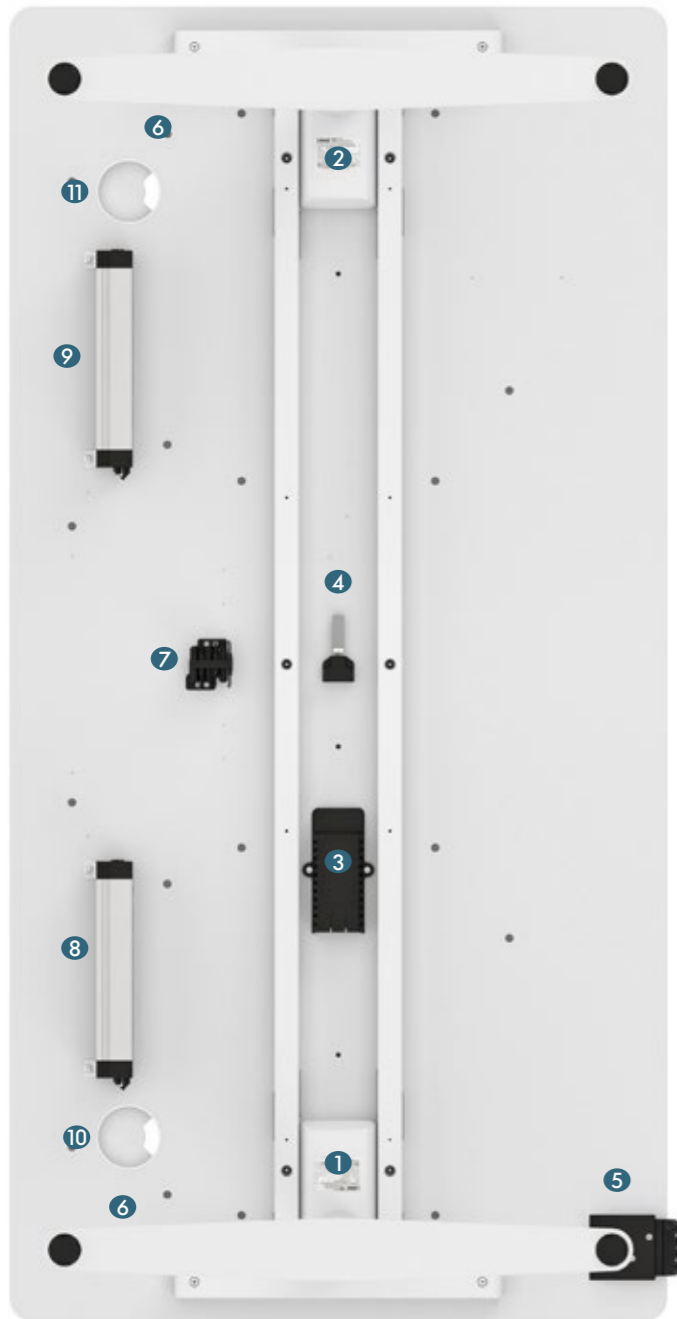

1. Master column
2. Follower column
3. Mains unit
4. Anti-collision device with desk sensor
5. Handset
6. Strain relief (left or right)
7. Distribution block (optional)
8. First under-table power socket (optional)
9. Second under-table power socket (optional)
10. Cable outlet on right (optional)
11. Cable outlet on left (optional)



Screen for single table

The screens are attached to the edge of the table top with a bracket, requiring no tools. The screens for single tables can also be mounted on cluster configurations, where they move up and down with the table to which they are attached.

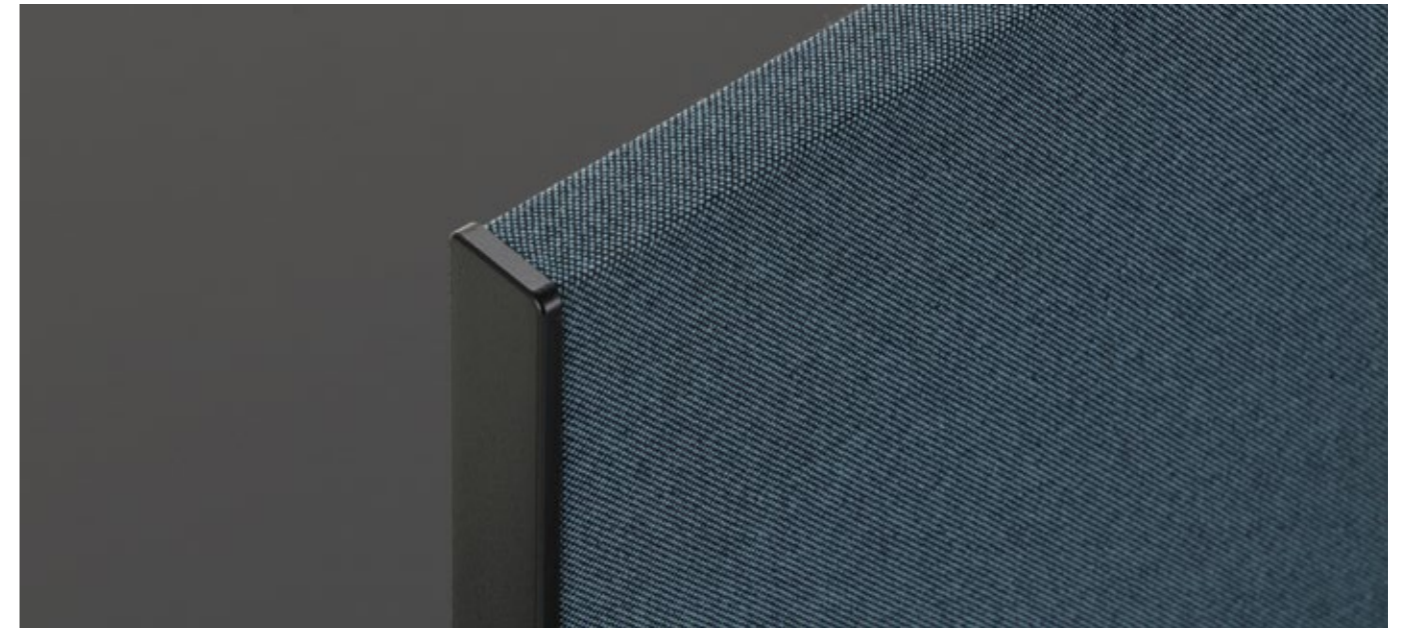

Sizes

Screens for single tables come in three sizes: 140 cm, 160 cm and 180 cm for tables of the same width. For enhanced acoustic insulation, screens are optionally available with a highly sound-absorbent core made of honeycomb paperboard.

**Cluster screen**

A special screen for clusters can be mounted between two cluster workstations. The cluster screen is attached to the cluster bridge and does not change its position when either table top is adjusted in height, so that the screen also serves as a modesty panel.

**Sizes**

The cluster screen comes in three sizes: 140 cm, 160 cm and 180 cm for tables of the same width. For enhanced acoustic insulation, screens are optionally available with a highly sound-absorbent core made of honeycomb paperboard.

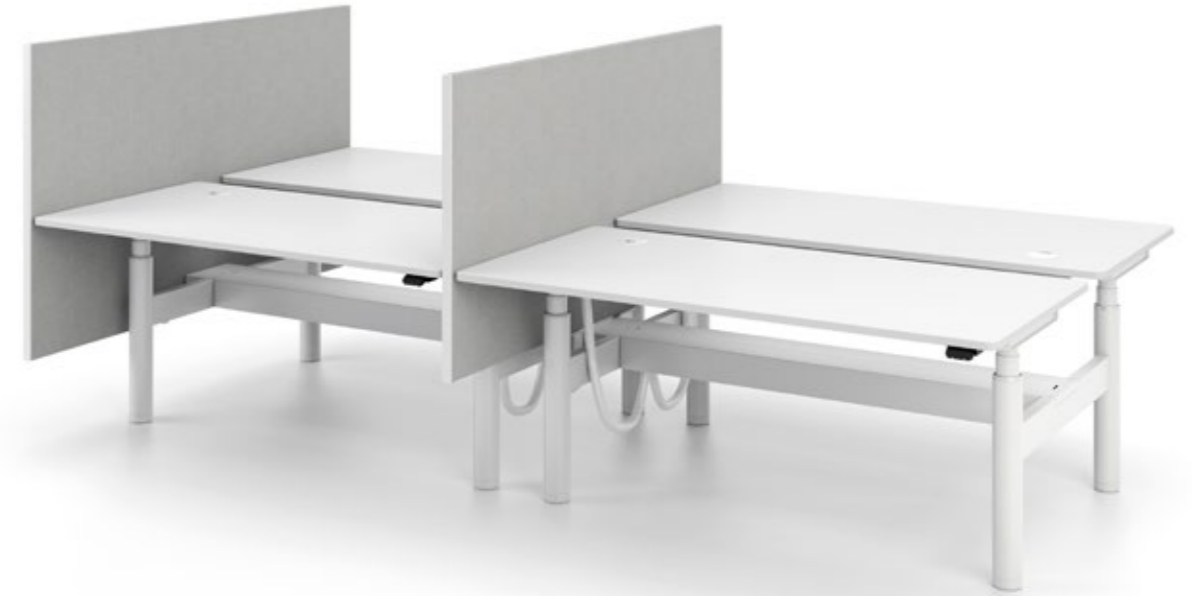
**Cluster side screen**

Side screens function as an end element on cluster configurations and are attached to the side of the cluster bridge. Side screens come in two sizes: 152 cm for clusters with 140-cm-wide tables, and 172 cm for clusters with 160- or 180-cm-wide tables. Upon request, side screens can also be mounted between two tables; please contact your Vitra sales partner. For enhanced acoustic insulation, screens are optionally available with a highly sound-absorbent core made of honeycomb paperboard.

Acoustic screen

**Acoustically effective screens**

All Tyde 2 screens are optionally available in a version with a honeycomb paperboard core, which provides excellent acoustic insulation. Lightweight, ecological and sturdy, these paperboard elements have a sine-wave structure that effectively absorbs ambient noise. Just like the standard screen, the entire panel is covered in fabric to conceal the construction.



Bracket mount

Bracket mounts are used to attach screens, lamps or monitor arms; they can be freely positioned along the edge of the table top and attached without tools. In addition to their use for Tyde 2, the brackets are compatible with any table top measuring between 22 and 28 mm in thickness.



Screens

Screens are mounted on two brackets with an extension piece. Lamps or monitor arms can also be optionally attached.



Lighting

Adapter for attaching various lamps to the bracket.



Monitor arm

Designed for monitor arm Humanscale M2.1., incl. rotation lock. For safety reasons, tools must be used to attach the bracket to the table top if a monitor arm is to be mounted on the bracket.



CPU holder

The CPU holder is attached to the frame structure and moves up and down with the table. It is mounted underneath the table top and can face inwards or outwards.

Colours and materials



vitra.

Plano Home/Office, F30

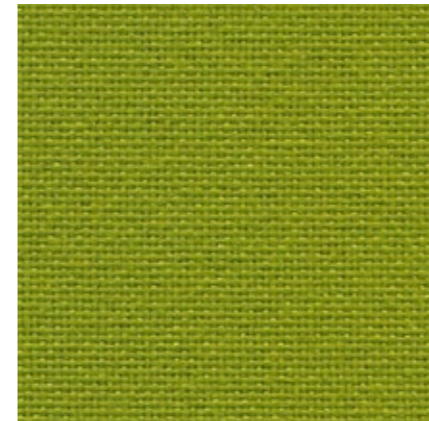

Plano is a robust plain weave with a flat, even texture. The wide palette of duotones with new, delicate washed-out shades includes many relatively neutral hues, a good number of which are coordinated with the Hopsak colour range. Thanks to its durability and longevity, Plano is also an ideal choice for office furnishings.

Plano is available in 39 colours.

vitra.

Material	100% polyester
Weight	265 g/m ² (7.8 oz/y ²)
Width	142 cm +/- 2 cm (56")
Abrasion resistance	80,000 Martindale
Fastness to light	Type 6
Pilling	Grade 4-5
Fastness to rubbing	Grade 4-5 dry and wet



Dimensions

vitra.

vitra.

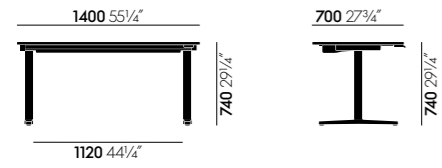

Tyde 2 table 140

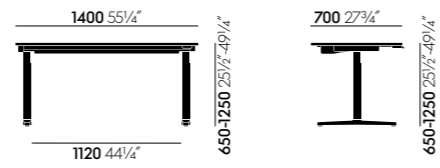

Tyde 2 sit-stand table 140

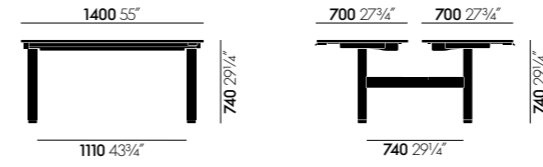

Tyde 2 cluster 140

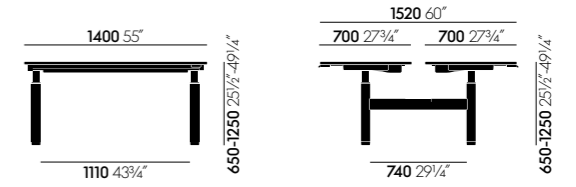

Tyde 2 sit-stand cluster 140

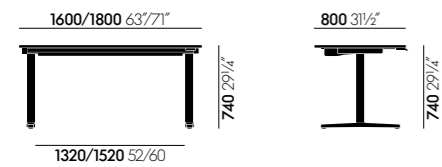
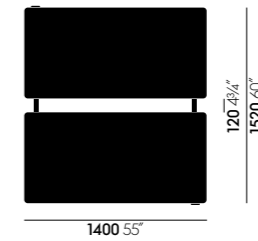
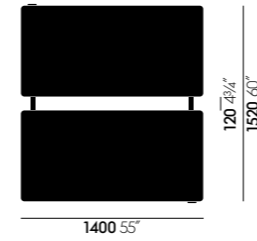
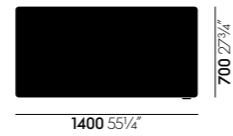
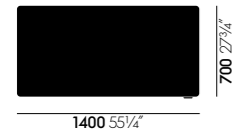

Tyde 2 table 160/180

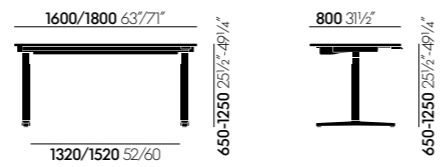

Tyde 2 sit-stand table 160/180

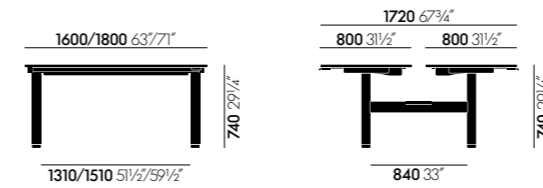

Tyde 2 cluster 160/180



Tyde 2 sit-stand cluster 160/180

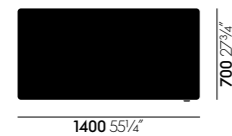

Tyde 2 sit-stand table on castors 140



Tyde 2 sit-stand table on castors 160/180

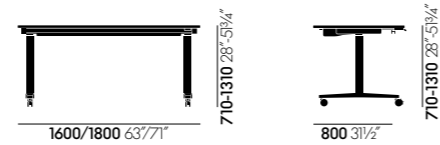
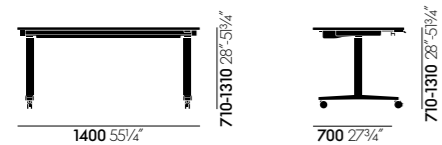

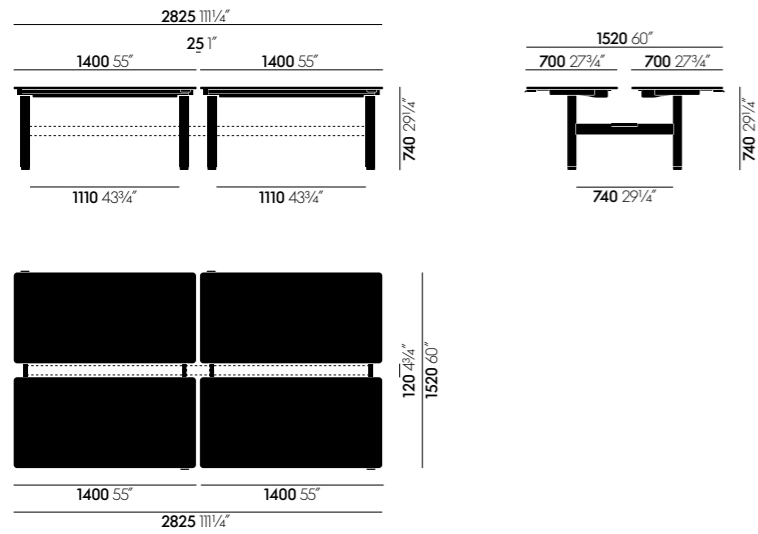

Tyde 2, Cluster 140, two pieces

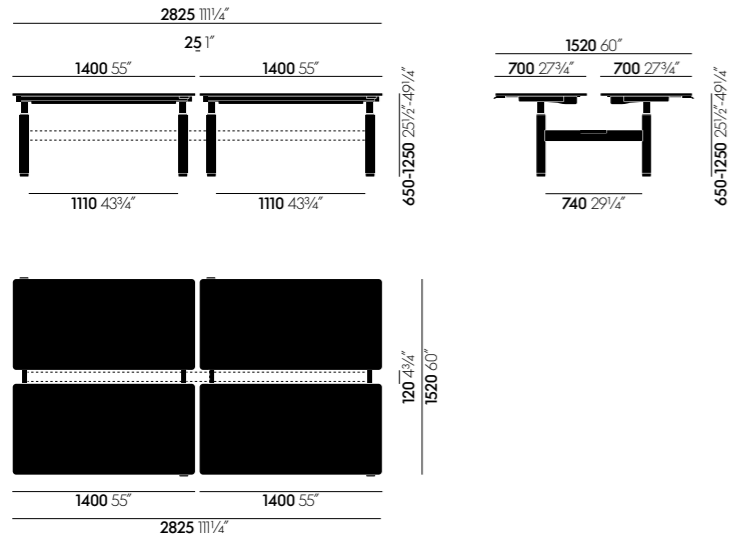

Tyde 2, Sit-stand cluster 140, two pieces

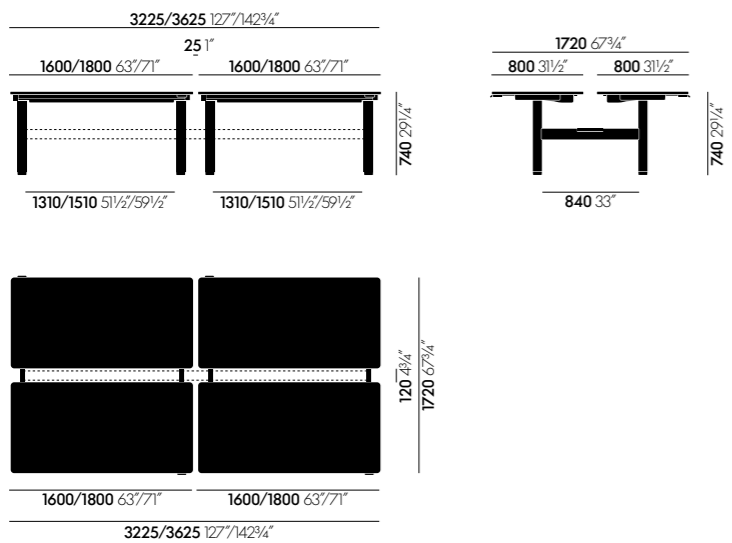

Tyde 2 Cluster 160/180, two pieces

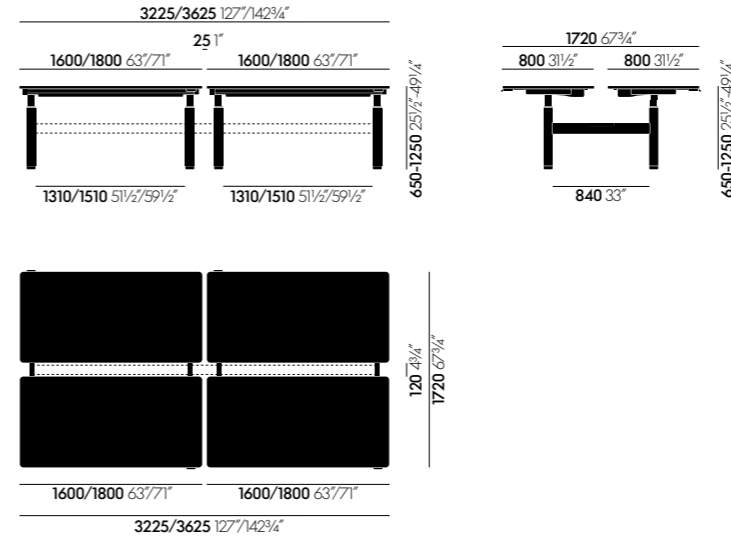

Tyde 2, Sit-stand cluster 160/180, two pieces

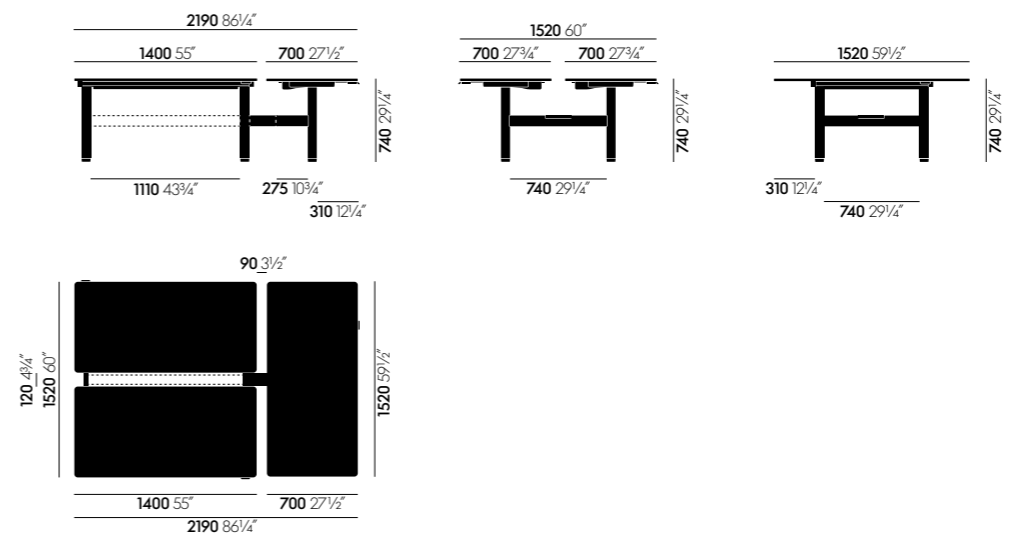

Tyde 2, Cluster 140 with add-on table for cluster 140

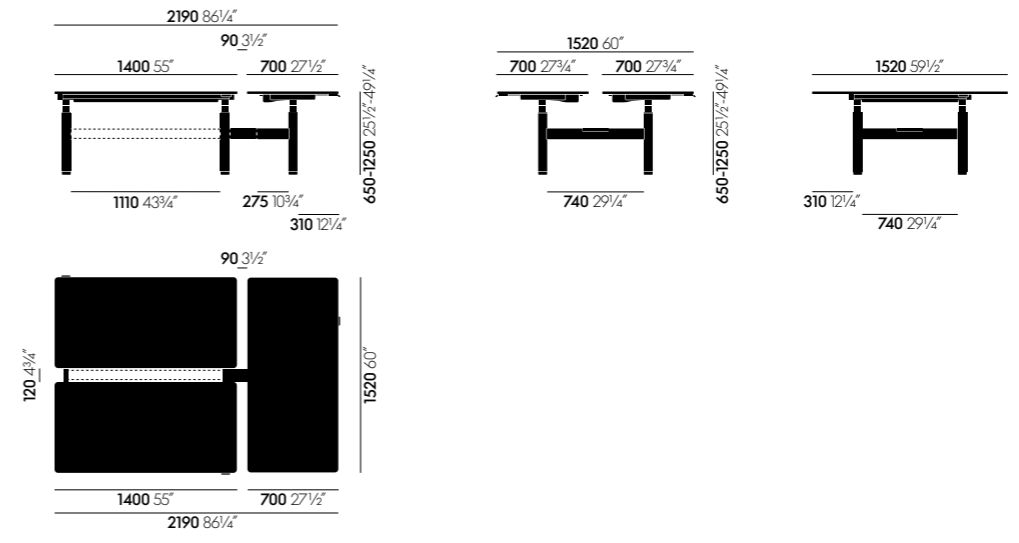

Tyde 2, Sit-stand cluster 140 with sit-stand add-on table for cluster 140

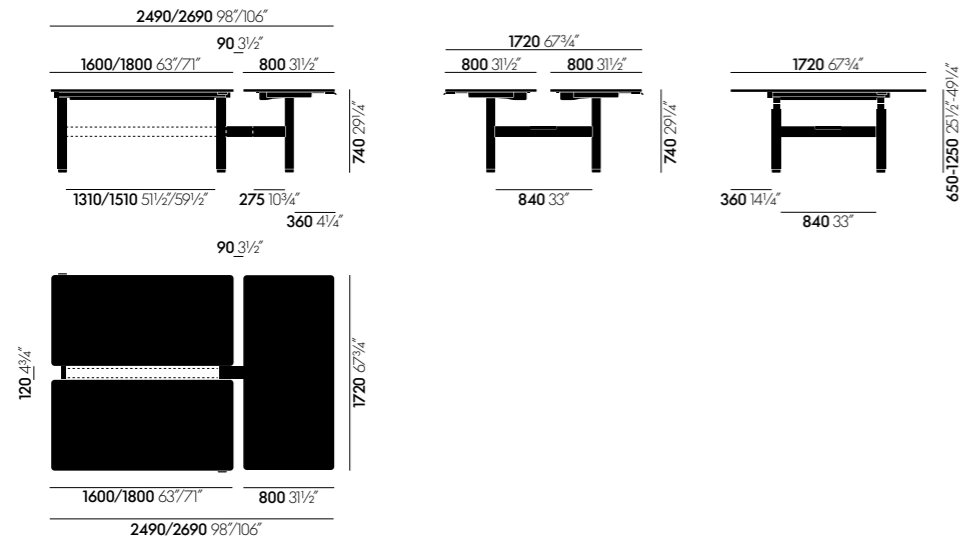

Tyde 2, Cluster 160/180 with add-on table for cluster 160/180

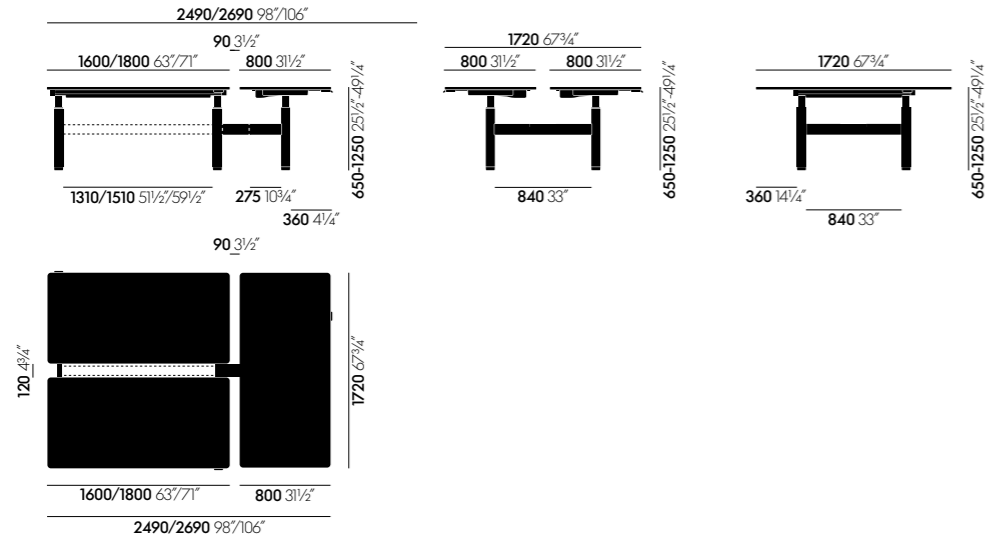

Tyde 2, Sit-stand cluster 160/180 with sit-stand add-on table for cluster 160/180

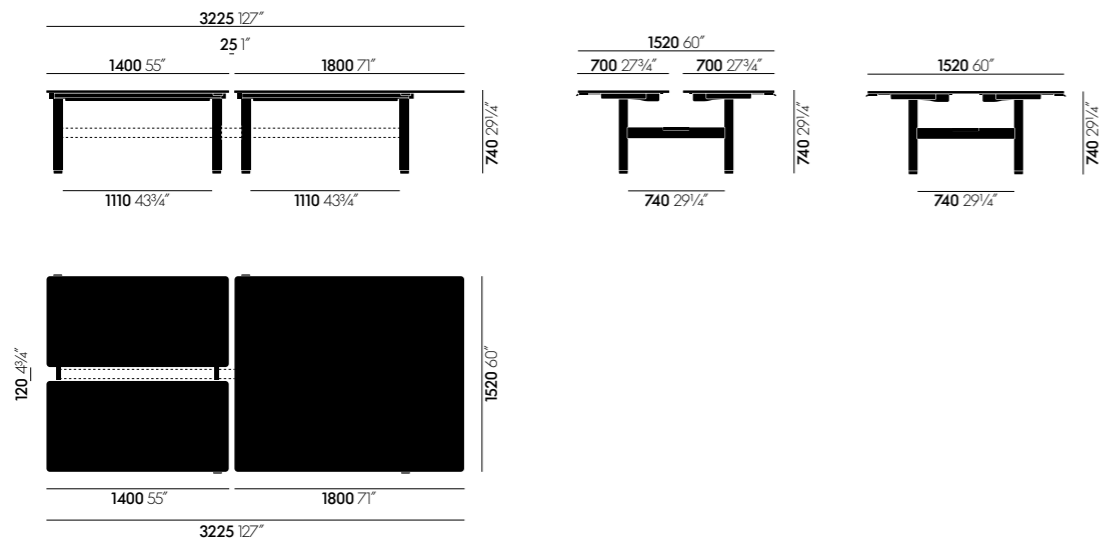

Tyde 2, Cluster 140 with meeting cluster 140

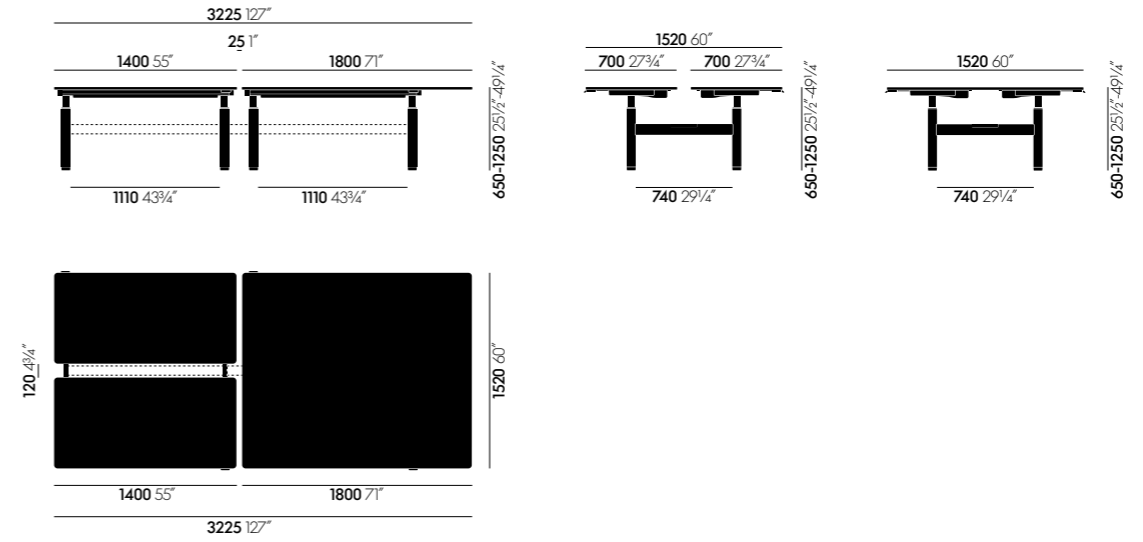

Tyde 2, Sit-stand cluster 140 with sit-stand meeting cluster 140

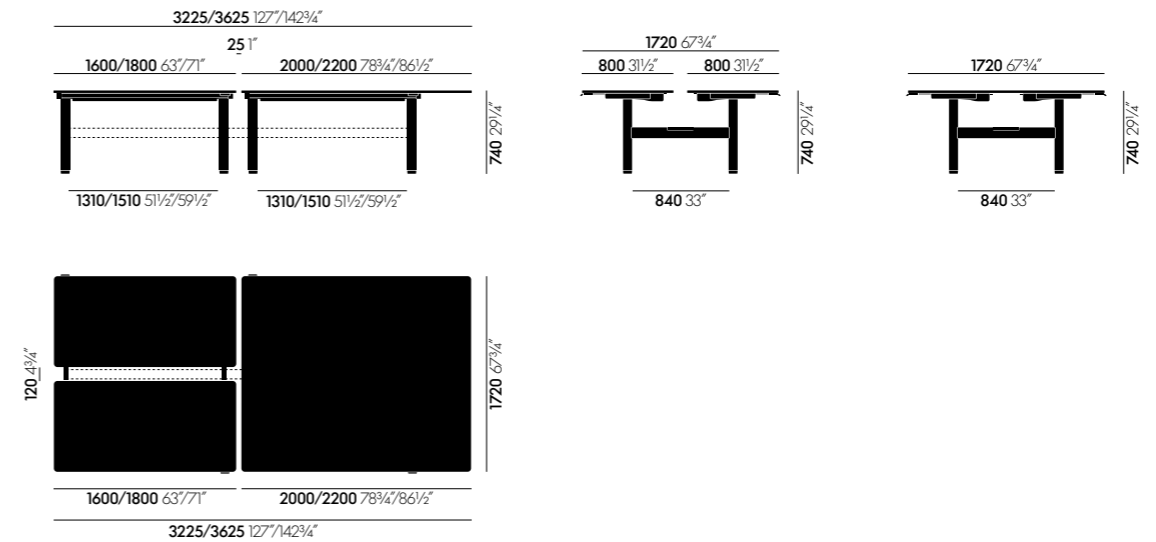

Tyde 2, Cluster 160/180 with meeting cluster 160/180

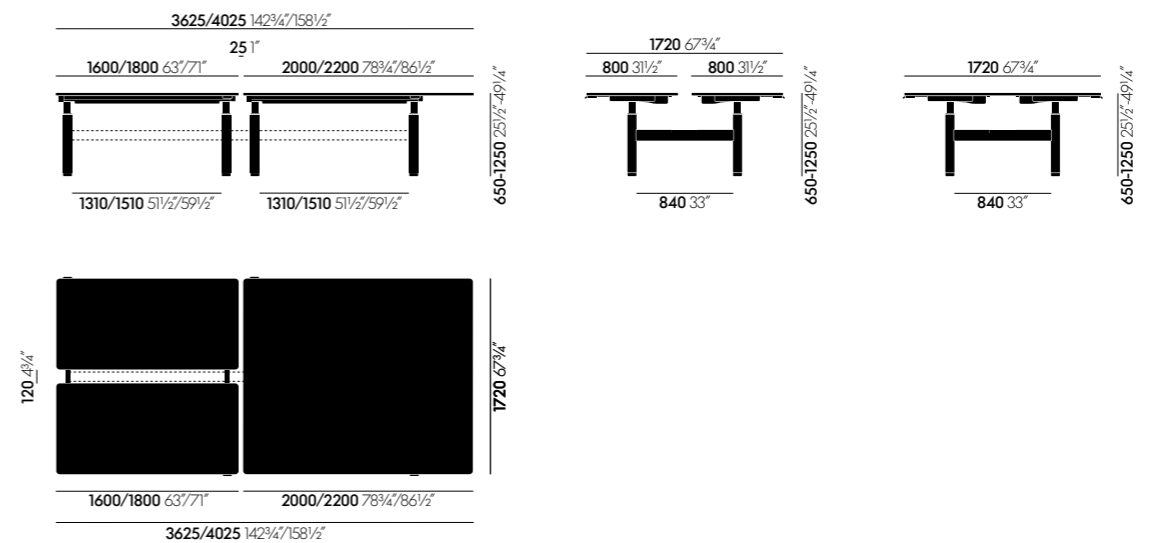

Tyde 2, Sit-stand cluster 160/180 with sit-stand meeting cluster 160/180

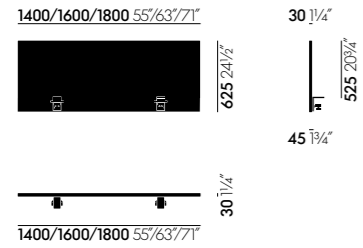

Tyde 2, screen for bracket mount

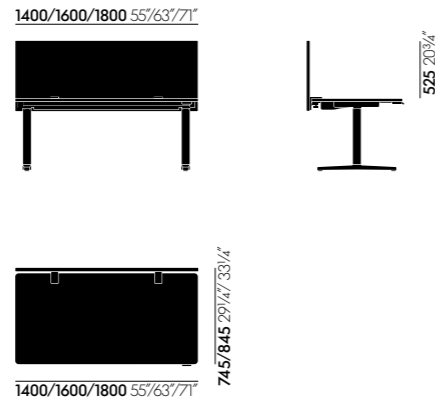

Tyde 2, table with screen for bracket mount

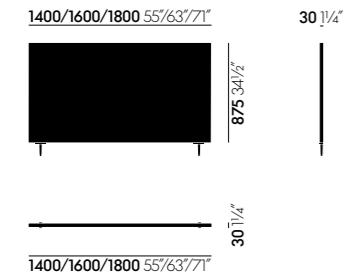

Tyde 2, Cluster screen

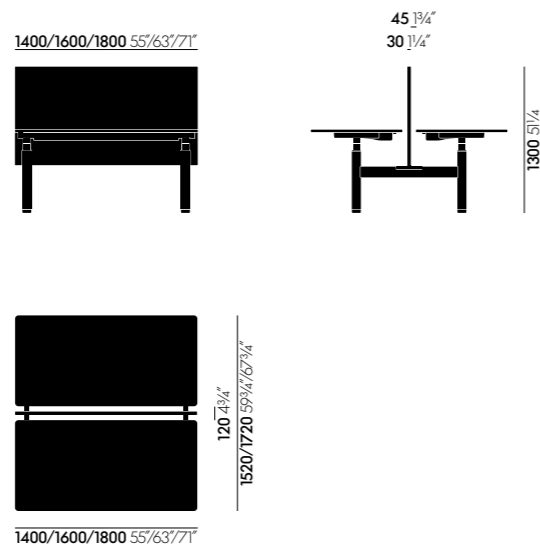

Tyde 2 Cluster with cluster screen

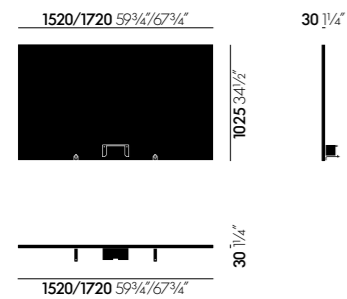

Tyde 2, Cluster side screen

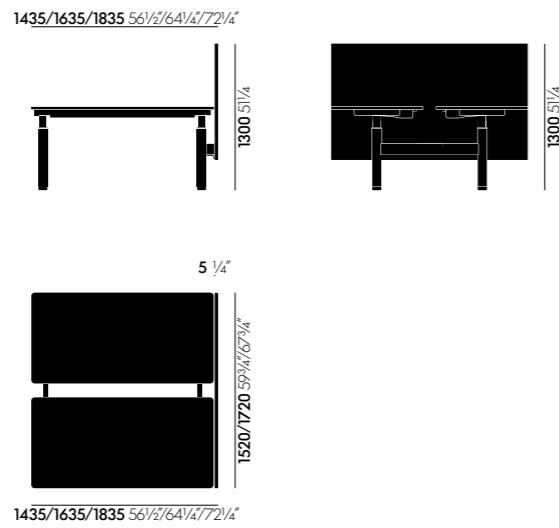

Tyde 2, Cluster with Cluster side screen

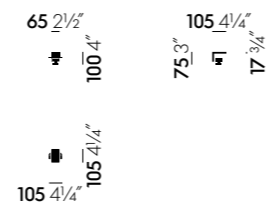

Tyde 2, bracket

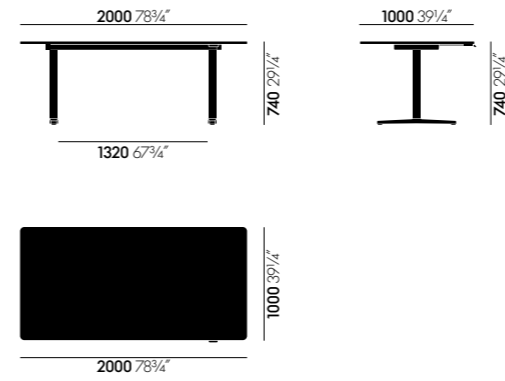

Tyde 2 meeting table 200

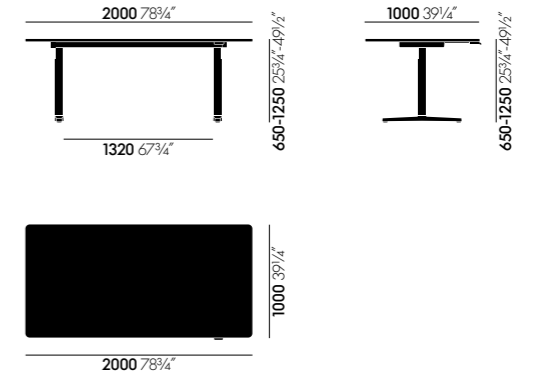

Tyde 2 sit-stand meeting table 200

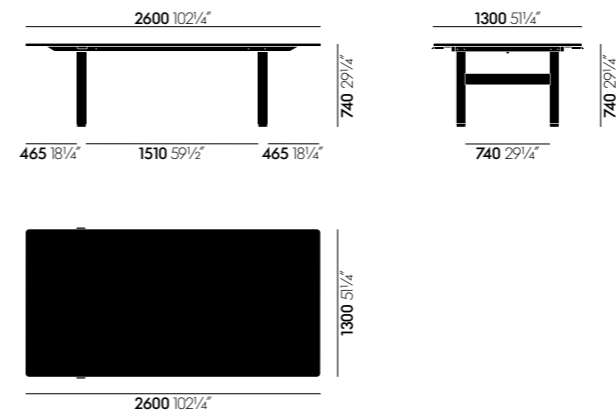

Tyde 2 meeting table 260

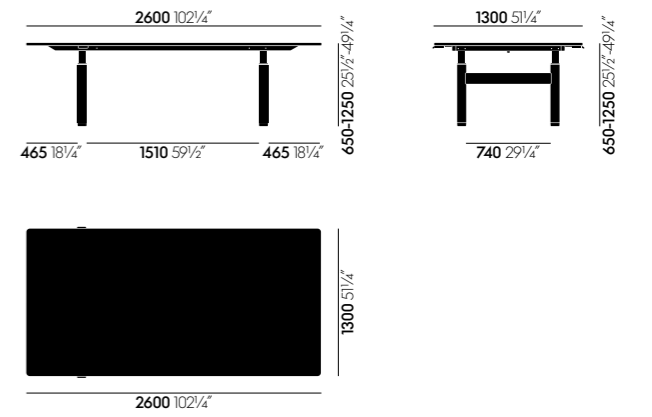

Tyde 2 sit-stand meeting table 260

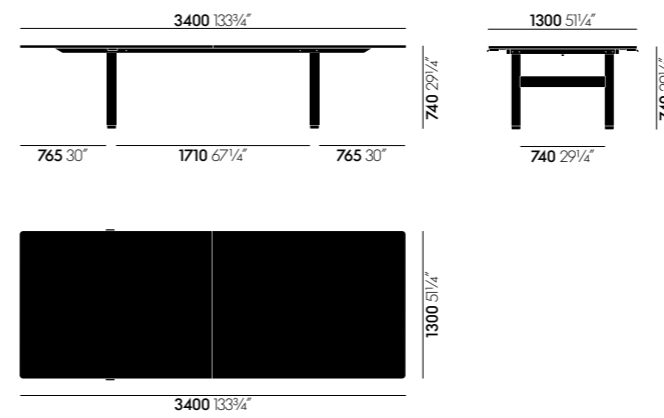

Tyde 2 meeting table 340

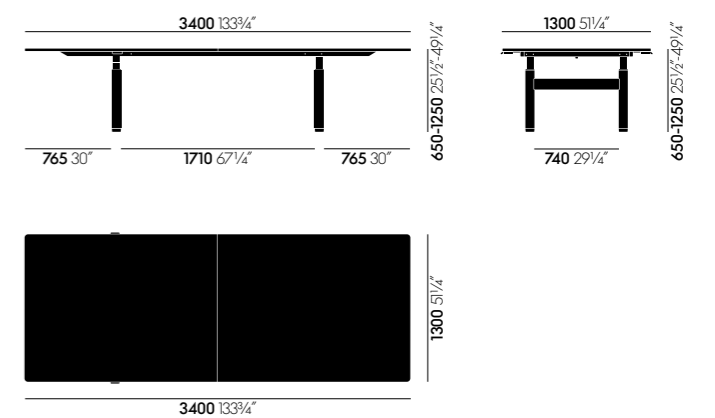

Tyde 2 sit-stand meeting table 340

